

**Article Info**

Received: 20 Oct 2014 | Revised Submission: 10 Nov 2014 | Accepted: 20 Nov 2014 | Available Online: 15 Dec 2014

---

**Rectangular Patch Antenna for Public Safety WLAN and IMT Band Applications**

*Mohd Nadeem Khan\**

---

**ABSTRACT**

*Engineering is an implementation of all that we study for inventing something new ideas and making things easy and applicable in the real world through practical study.*

*This paper presents a multi band rectangular patch antenna. The slotted antenna is a dual band antenna. The two bands produced are used for IMT band(3.97 GHz) and public safety WLAN (4.94 GHz-4.99 GHz) applications. The frequency used to set design parameters is 4.96 GHz, so our main focus is on the second public safety WLAN band. The feeding technique used for feeding the antenna is coaxial probe feeding technique. When slotted antenna is compared with a conventional rectangular patch antenna it is seen that slotted antenna is better. Here dual band slotted patch antenna for public safety spectrum and IMT band applications is being designed.*

**Keywords:** WLAN; IMT band Slotted Antenna; Patch Antenna.

---

**1.0 Introduction**

Now a days microstrip patch antennas are widely used in many Applications, its major use in wireless communication. The microstrip patch antenna has been designed and analyzed by many research scholars. "Many of them have been made on exploring more efficient antenna". In 1997 C.A. Balanis[7] has introduced many concepts which are needful in designing a good antenna and in the year 2011 Vinod Kumar, Zakir Ali and Ashutosh Kumar [8], have presented a dual wideband stacked patch antenna for WiMAX and WLAN applications, here stacking configuration gives better bandwidth as compared to single layer substrate design. Afterwards Suhaila Subahir, Noraini Binti Abd Wahab & Wan Norsyafizan W. Muhammad [9] in year 2011, have presented the design of a microstrip patch antenna for dual frequency operation at 2.1 GHz and 5.8 GHz for GPS and WiMAX applications respectively. Also U. Chakraborty, S. Chatterjee, S.K. Chowdhury & P.P. Sarkar[2] in 2011, have designed compact microstrip patch antenna for wireless communication. The antenna was mainly for WiMAX frequency range of 3.2-3.8 GHz. An optimization between size reduction and bandwidth enhancement was maintained in this work. In year 2012 Vinay and Reena[1], have done comparison of microstrip antenna and microstrip

antenna with slots for microwave life detection system. Here bandwidth of microstrip patch antenna with slots was improved as compared to microstrip antenna without slots. Here basics of obtaining good radiation efficiency were also discussed. In the same year Sudipta Das, Dr. P.P. Sarkar & Dr. S.K. Chowdhury, have presented a design of a compact novel multi frequency slotted microstrip patch antenna for WiMAX and C band applications. Here after introducing slots at the edges of the rectangular patch a size reduction of about 66% was achieved. Later on in year 2012 Barun Mazumdar[5], have presented a compact L-slit microstrip antenna for GSM, Bluetooth, WiMAX & WLAN applications. Here Neltec NX 9240 epoxy material was used. Here slit reduced the size of an antenna by 63% and increased the bandwidth up to 53.13 MHz with a return loss of -29.25 dB, absolute gain about 6.53 dBi. Moreover efficiency 82% was achieved. Islam, Hussein, Hani [6], has designed a three port MIMO antenna for 4G application. There were various applications of this patch antenna designed in 2012. In year 2014 Dheeraj, Deepak, Komal designed dual band broadband modified rectangular microstrip antenna with air gap for wireless applications [10].

From above it can be seen that many researchers have been done before. However, most of these bear disadvantages in the degradation of the

---

\*Department of Electronic & Compunction Engineering, IIMT College of Engineering, Meerut, Uttar Pradesh, India  
(E-mail: nadeemkhanmohd@gmail.com)

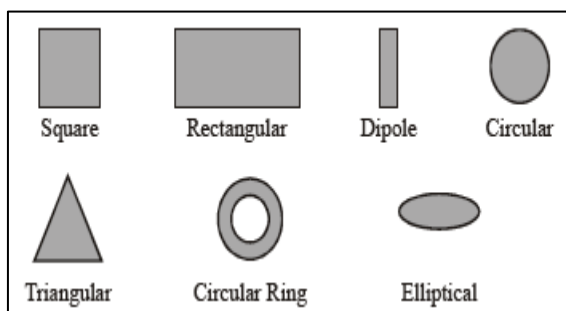
many characteristics, while improving certain characteristics. It is the purpose of this thesis to improve various multiple characteristics of slotted patch antenna for public safety spectrum. Here the resonant frequency selected in designing is 4.96 GHz, hence emphasis is mainly on the public safety WLAN band. Moreover first band for various applications at 3.97 GHz (IMT band) is also available. Second most important work in this paper is the comparison of slotted and basic patch antennas.

### 1.1 Microstrip antenna and its properties

The Microstrip Patch antennas have a radiating patch on one side of a dielectric substrate which has a ground on the other side as shown in Fig. 1. The patch is mainly made of conducting material such as copper or gold and can take any possible shape. The radiating patch and the feed lines are usually photo etched on the substrate.

In order to make easier analysis and performance prediction, the patch is generally square, rectangular, circular, triangular, and elliptical or some other common shape as shown in Fig. 2 For a rectangular patch, the length  $L$  of the patch is usually  $0.3333\lambda_0 < L < 0.5\lambda_0$ , where  $\lambda_0$  is the free-space wavelength. The patch is selected to be very thin such that  $t \ll \lambda_0$  (where  $t$  is the patch thickness). The height  $h$  of the dielectric substrate is usually  $0.003\lambda_0 \leq h \leq 0.05\lambda_0$ . The dielectric constant of the substrate ( $\epsilon_r$ ) is typically in the range  $2.2 \leq \epsilon_r \leq 12$ .

**Fig 2: Common Shapes of Microstrip Patch Elements**



Microstrip patch antennas radiate primarily because the fringing fields are there between the patch edge and the ground. For good antenna performance, a thick dielectric substrate having a low dielectric constant is required since this provides better efficiency, larger bandwidth and better

radiation [4]. However, such a configuration leads to a larger antenna size. In order to design a compact microstrip patch antenna, substrates with higher dielectric constants must be used which are less efficient and result in narrower bandwidth. Hence a trade-off is between the antenna dimensions and antenna performance.

## 2.0 Feed Techniques

Microstrip patch antennas can be fed by a variety of methods. These methods can be classified into two categories- contacting and non-contacting. In the contacting method, the RF power is fed directly to the radiating patch using a connecting element such as a microstrip line. In the non-contacting scheme, electromagnetic field coupling is done to transfer power between the microstrip line and the radiating patch [4]. The four popular feed techniques used are the microstrip line (contacting scheme), coaxial probe (contacting scheme), aperture coupling (non-contacting scheme) and proximity coupling (non-contacting scheme).

1. Microstrip Line Feed
2. Coaxial Feed
3. Aperture Coupled Feed
4. Proximity Coupled Feed

### 2.1 Methods of analysis

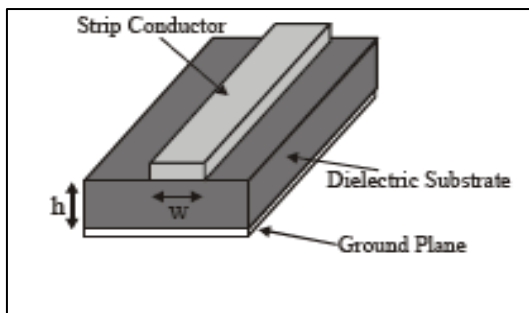
Models which are usually preferred for the analysis of microstrip patch antennas are transmission line model, cavity model, and full wave model [4]. The transmission line model is the simplest of all and it gives great physical insight but it is less accurate. The cavity model is more accurate and gives good physical insight but is complex in nature. The full wave models are fully accurate, versatile and can treat single elements, finite and infinite arrays, stacked elements, arbitrary shaped elements and coupling. These give less insight as compared to the two models mentioned above and are far more typical in nature. Here transmission line and cavity models are explained.

#### 2.1.1 Transmission line model

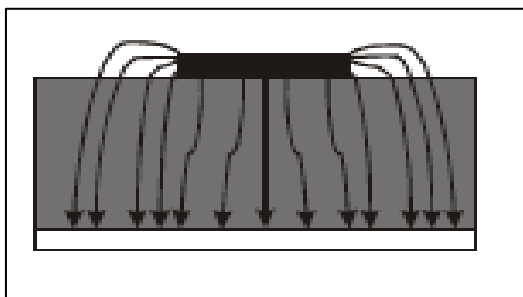
This model represents the microstrip antenna by two slots of width  $W$  and height  $h$ , separated by a transmission line of length  $L$ . The microstrip is essentially a non-homogeneous line of two dielectrics, typically the substrate and air. Hence, as

seen from Fig. 4, many electric field line reside in the substrate and parts of some lines in air. As a result, this transmission line cannot support pure transverse-electric- magnetic (TEM) mode of transmission, since the phase velocities would be different in the air and the substrate. Instead, the dominant mode of propagation would be the quasi-TEM mode. Hence, an effective dielectric constant ( $\epsilon_{\text{reff}}$ ) must be obtained in order to account for the fringing and the wave propagation in the line. The value of  $\epsilon_{\text{reff}}$  is slightly less than  $\epsilon_r$  because the fringing fields around the periphery of the patch are not confined in the dielectric substrate as well as spread in the air as shown in Fig. 2.2 above. The expression for  $\epsilon_{\text{reff}}$  is given by Balanis as:

**Fig 3: Microstrip line**



**Fig. 4. Electric field lines**



$$\epsilon_{\text{reff}} = \left( \frac{\epsilon_r + 1}{2} \right) + \frac{(\epsilon_r - 1)}{2} * \frac{1}{\sqrt{1 + \frac{12h}{w}}} \quad (1)$$

Where

$\epsilon_{\text{reff}}$  = Effective dielectric constant

$\epsilon_r$  = Dielectric constant of substrate

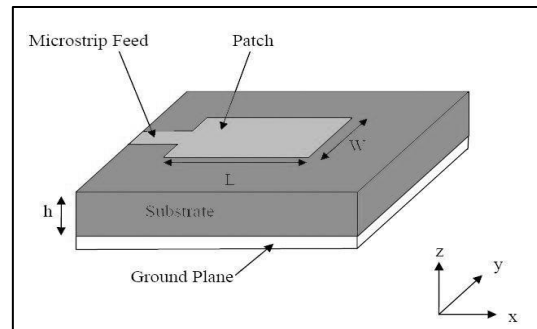
$h$  = Height of dielectric substrate

$W$  = Width of the patch

Consider Fig. 5 below that shows a rectangular microstrip patch antenna of length  $L$ , width  $W$  resting

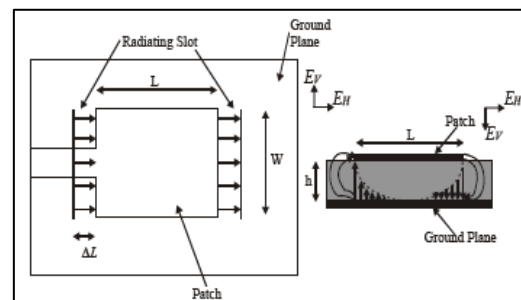
on a substrate of height  $h$ . The co-ordinate axis is selected such as the length is along the  $x$  direction, width is along the  $y$  direction and the height is along the  $z$  direction.

**Fig 5: Microstrip Patch Antennas**



In order to operate in the fundamental TM<sub>10</sub> mode, the length of the patch must be slightly less than  $\lambda/2$  where  $\lambda$  is the wavelength in the dielectric medium and is equal to  $\lambda_0/\sqrt{\epsilon_{\text{reff}}}$  where  $\lambda_0$  is the free space wavelength. The TM<sub>10</sub> mode implies that the field varies one  $\lambda/2$  cycle along the length, and there is no change along the width of the patch. In the Fig. 2.4 shown on next page, the microstrip patch antenna is represented by two slots, separated by a transmission line of length  $L$  and open circuited at both the ends. Along the width of the patch, the voltage is maximum and current is minimum due to the open ends. The fields at the edges can be resolved into normal and tangential components with respect to the ground plane. Here in this thesis various formulas from transmission line model have been taken for the calculation of antenna parameters.

**Fig 6: Top View of Antenna, Fig. 7. Side View of Antenna**



It is seen from Fig. 7. that the normal components of the electric field at the two edges

along the width are in opposite directions and thus out of phase since the patch is  $\lambda/2$  long and hence components cancel each other in the broadside direction. The tangential components (see Fig. 7), which are in phase, means that the resulting fields combine to give maximum radiated field normal to the surface of the structure. Hence the edges along the width can be represented as two radiating slots, which are  $\lambda/2$  apart and excited in phase and radiating in the half space above the ground plane. The fringing fields along the width can be modeled as radiating slots and electrically the patch of the microstrip antenna looks greater than its physical dimensions. The dimensions of the patch along its length have now been extended on each end by a distance  $\Delta L$ , which is given empirically by Hammerstad as:

$$\Delta L = \frac{0.412h(\epsilon_{re} + 0.3)\left(\frac{W}{h}\right) + 0.264}{(\epsilon_{re} - 0.258)\left(\frac{W}{h}\right) + 0.8} \quad (2)$$

The length of the patch is

$$L = L_{effective} - 2\Delta L \quad (3)$$

For given resonance frequency  $f_0$ , the effective length is given as:

$$L_{effective} = \frac{c}{2f_0\sqrt{\epsilon_{re}}} \quad (4)$$

Width of patch is given by

$$W = \frac{c}{2f_0\sqrt{\left(\frac{\epsilon_r + 1}{2}\right)}} \quad (5)$$

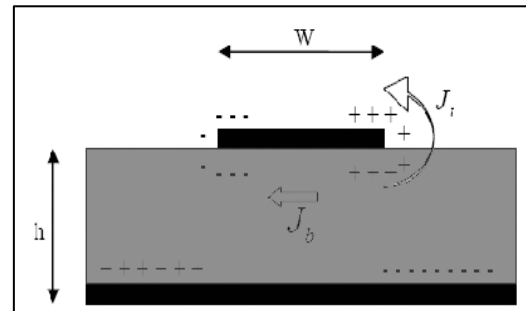
### 2.1.2 Cavity model

The cavity model helps to give insight into the radiation mechanism of an antenna, since it gives a mathematical solution for the electric and magnetic fields of a microstrip antenna. It does this by using a dielectrically loaded cavity to represent the antenna. This technique models the substrate material, but it assumes that the material is truncated at the edges of the patch. The patch and ground plane are represented with perfect electric conductors and the edges of the substrate are modeled with perfectly conducting magnetic walls.

Consider Fig. 8 shown above. When the microstrip patch is provided power, a charge distribution is seen on the upper and lower surfaces of the patch and at the bottom of the ground plane. This charge distribution can be controlled by two

mechanisms, an attractive mechanism and a repulsive mechanism. The attractive mechanism is between the opposite charges on the bottom side of the patch and the ground plane that helps in keeping the charge concentration intact at the bottom of the patch. The repulsive mechanism is between the like charges on the bottom surface of the patch that causes pushing of some charges from the bottom, to the top of the patch. As a result of this charge movement, currents flow at the top and bottom surface of the patch. The cavity model assumes that the height to width ratio (i.e. height of substrate and width of the patch) is very small and consequently the attractive mechanism dominates and causes most of the charge concentration and the current to be below the patch surface. Hence, the four sidewalls could be modeled as perfectly magnetic conducting surfaces. Next to discuss are the various properties of an antenna.

**Fig 8: Charge Distribution and Current Density Creation on the Microstrip Patch**



## 3.0 Antenna Designs and Simulated Results

### 3.1 Design specifications

The essential parameters for the design of rectangular patch antenna are:

- (1) **Frequency of operation ( $f_0$ ):** The resonant frequency of the antenna must be selected appropriately. The IEEE 802.11y uses the 4.9 GHz band whose frequency range lies between 4.940 GHz-4.990 GHz. My main focus is on IEEE802.1y application. So the resonant frequency selected for my design is 4.96 GHz.
- (2) **Dielectric constant of the substrate ( $\epsilon_r$ ):** The dielectric material selected for my design is Neltec NX 9240 epoxy [5] which has a dielectric constant of 2.4.
- (3) **Height of dielectric substrate ( $h$ ):** It is essential that the antenna should not be bulky. Hence, the

height of the dielectric substrate is selected as 1.5 mm.

**3.2 Design models**

The transmission line model is being used to design the patch antenna. Various formulas are taken from [3]. The design parameters are calculated by the following steps:

**Step 1:** Calculation of patch width is a first step. The following formula is used to calculate patch width  $w$  (2.1)

$$W = \frac{c}{2f_0 \sqrt{\frac{\epsilon_r + 1}{2}}} \tag{2.1}$$

Where  $f_0$  is resonant frequency,  $\epsilon_r$  is substrate dielectric constant and  $c$  is velocity of light. Here basic parameters  $f_0$  &  $\epsilon_r$  used for calculations are 4.96 GHz and 2.4 respectively.

**Step 2:** In second step the  $\epsilon_{\text{reff}}$  is calculated. To calculate effective dielectric constant  $\epsilon_{\text{reff}}$ , the formula is (2.2)

$$\epsilon_{\text{reff}} = \left\{ \frac{\epsilon_r + 1}{2} \right\} + \frac{\epsilon_r - 1}{2} * \frac{1}{\sqrt{1 + \frac{12h}{W}}} \tag{2.2}$$

Where  $\epsilon_r$  is substrate dielectric constant,  $h$  is substrate height above ground and  $w$  is the width of patch. Design parameter  $h$  used here is 1.5 mm.

**Step 3:** In third step  $\Delta L$  is calculated. Formula for Length extension  $\Delta L$  is (2.3)

$$\Delta L = \frac{0.412h(\epsilon_{\text{reff}} + 0.3) \left\{ \left( \frac{W}{h} \right) + 0.264 \right\}}{(\epsilon_{\text{reff}} - 0.258) \left\{ \left( \frac{W}{h} \right) + 0.8 \right\}} \tag{2.3}$$

Where  $\epsilon_{\text{reff}}$  is effective dielectric constant,  $h$  is substrate height above ground and  $w$  is the width of the patch.

**Step 4:** Fourth step is to calculate  $L_{\text{effective}}$ . Formula for  $L_{\text{effective}}$  is (2.4)

$$L_{\text{effective}} = \frac{c}{2f_0 \sqrt{\epsilon_{\text{reff}}}} \tag{2.4}$$

It is calculated with the help of  $c$ ,  $f_0$  &  $\epsilon_{\text{reff}}$ .

**Step 5:** Next, Patch length is calculated by the following formula (2.5)

$$L = L_{\text{effective}} - 2\Delta L \tag{2.5}$$

**Step 6:** In the next step the ground length is calculated with the help of following formula (2.6)

$$L_g = 6h + L \tag{2.6}$$

**Step7:** In seventh step ground width is calculated by the following formula (2.7)

$$W_g = 6h + W \tag{2.7}$$

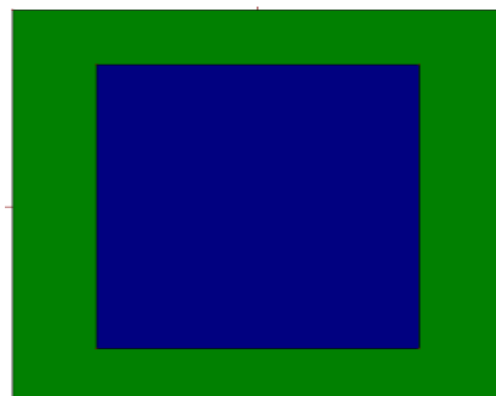
Finally the various parameters taken for the design are as follows

**Table 1: Various design parameters**

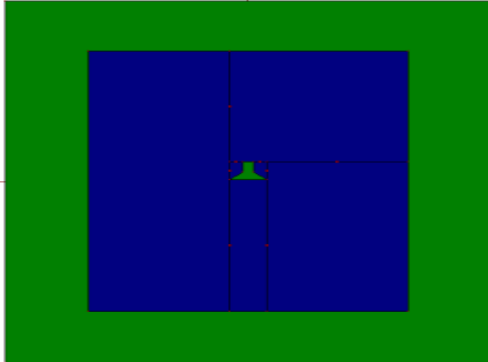
S. No.	Parameter	Value
1	$f_0$	4.96 GHz
2	$\epsilon_r$	2.4
3	$W$	23.19 mm
4	$H$	1.5 mm
5	$L$	18.30 mm
6	$l_g$	27.74 mm
7	$w_g$	32.19 mm

The rectangular patch antenna is designed with the help of various parameters as shown in Table 1, length of patch taken is 18, 30 mm, calculated width of patch is 23.19 mm, ground length is 27.74 mm and ground width is 32.19 mm. various formulas were taken from the transmission line model. The designed basic microstrip rectangular patch antenna is shown in Fig. 9. Various parameters can be seen from table 1. IE3D zeland software is used in designing of this rectangular patch antenna. Now if we want to improve the various properties of antenna then we have to make a slot in a patch. Figure 10 will present the slotted rectangular patch antenna, where a torch shaped slot has been made.

**Fig: 9. Designed Basic Microstrip Rectangular Patch Antenna**



**Fig 10: Designed Slotted Microstrip Rectangular Patch Antenna**



Now to improve the antenna performance a small slot is made at the middle of patch in the designed antenna as shown in the Fig. 10.

**3.3 Results and discussions**

**3.3.1 Basic rectangular patch antenna simulation results**

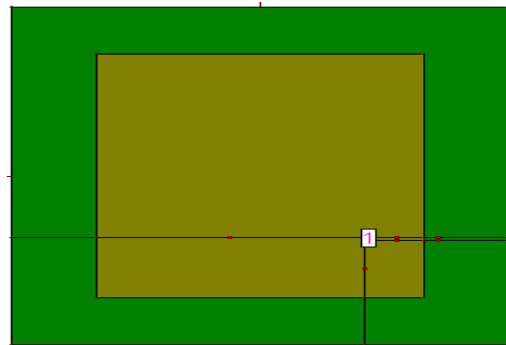
The simulations are being carried out on IE3D software. Here are the various results obtained for the rectangular patch antenna. The following table shows the list of feed points and their respective return losses. From the simulation table that feed point is selected which produces the maximum return loss (smaller than -9.5 dB). The feed point (6,-6) gives the maximum return loss for both the bands, so it is selected as best feed point for this particular antenna. The given best feed point is shown by bold in Table 2 which is a simulation table for rectangular patch antenna and the table is given below.

**Table 2: Simulation Table for Basic Rectangular Patch Antenna**

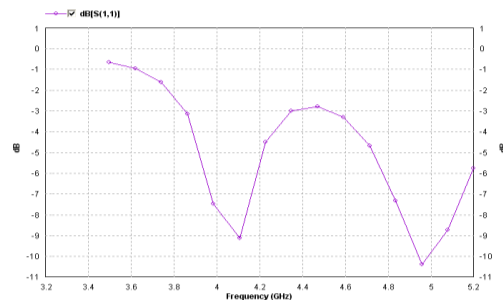
S. No.	Feed point location	Return loss (4.9 GHz band)
1	(0,0)	-0.14 dB
2	(1,1)	-1.20 dB
3	(1,2)	-1.27 dB
4	(2,1)	-4.42 dB
5	(2,2)	-4.56 dB
6	<b>(6,-6)</b>	<b>-10.33 dB</b>
7	(7,-9)	-9.0 dB
8	(7,-1)	-9.54 dB
9	(7,-6)	-8.65 dB
10	(6,-8)	-9.99 dB
11	(-3,-4)	-9.4 dB
12	(7,-10)	-9.65 dB

Hence the rectangular patch antenna showing the respective feed point is given below in fig 11, it should be noted that this antenna is the basic patch antenna without any slot. Here at feed point (6,-6) a return loss of -10.33 dB for 4.9 GHz band of IEEE 802.11y is obtained.

**Fig 11: Designed Basic Rectangular Patch Antenna Showing Feed Point (6,-6)**



When simulation was carried out then, return loss of -10.33 dB was obtained at 4.96 GHz. This is a return loss for the 4.9 GHz band of IEEE public safety spectrum. It could be noted from Fig. 12 that these are the results for basic rectangular patch antenna without having any slot. Graph on the next page is showing return loss for unslotted antenna.



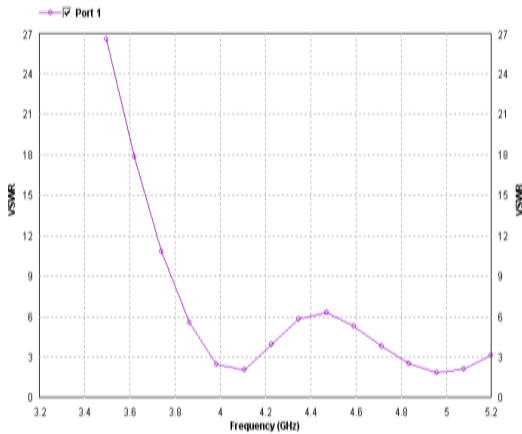
From the above Fig. 12 it can be seen that antenna is giving a return loss of -10.33 dB, which can be used for 802.11y applications.

Standing wave ratio (SWR) is the ratio of maximum amplitude of the standing wave to the minimum amplitude of wave. SWR is a measure of what is happening to the forward and reverse voltage signals and how they are when compare in size.

Hence VSWR represents the ratio between the maximum and minimum amplitudes of the standing wave. The VSWR (Voltage Standing Wave Ratio) of 1.87 was obtained at 4.96 GHz. The VSWR

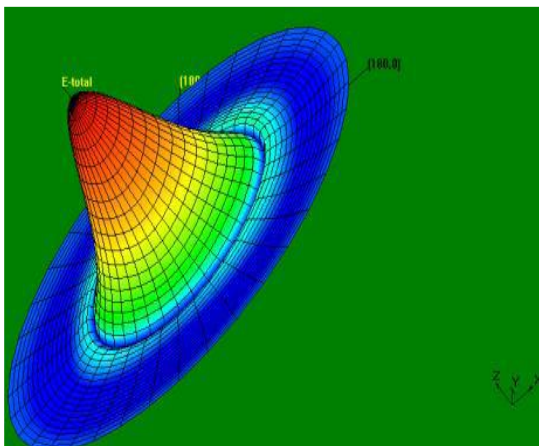
is between 1 & 2. The figure given below shows the VSWR of a basic antenna without having slot

**Fig 13: VSWR of Rectangular Patch Antenna at Feed Point (6,-6)**



Also the radiation pattern obtained at 4.95 GHz is shown in the Fig. 14 Here radiation properties of antenna as a function of space coordinates are represented graphically.

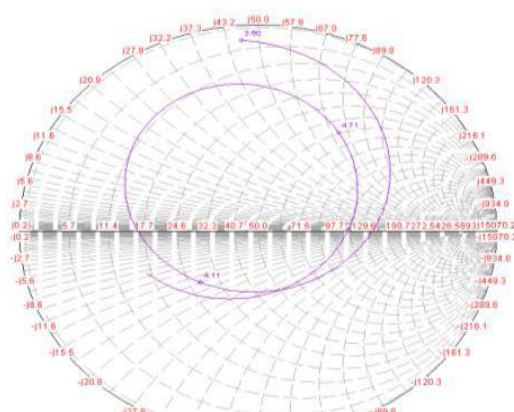
**Fig: 14 Radiation Pattern of Basic Rectangular Patch Antenna at Feed Point (6,-6)**



The smith chart for designed rectangular patch antenna is shown in the Fig. 15 on next page, here reflection coefficient is displayed graphically by using a smith chart for rectangular patch antenna. From smith chart a reflection coefficient of 0.30 is obtained for the 4.9GHz band. Since reflection coefficient represents the ratio of amplitude of reflected signal to the incident signal, so it should be minimum for better antenna performance. The smith

chart shown in Fig 15 is for the Basic rectangular patch antenna without having any slot.

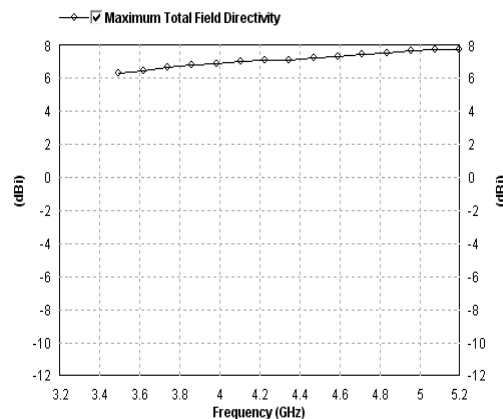
**Fig 15: Smith Chart (Showing Reflection Coefficient of 0.30 at 4.9 Ghz Band) for Basic Rectangular Patch Antenna**



Smith chart for slotted rectangular patch antenna will also be seen afterwards when simulation results for slotted rectangular patch antenna will be presented.

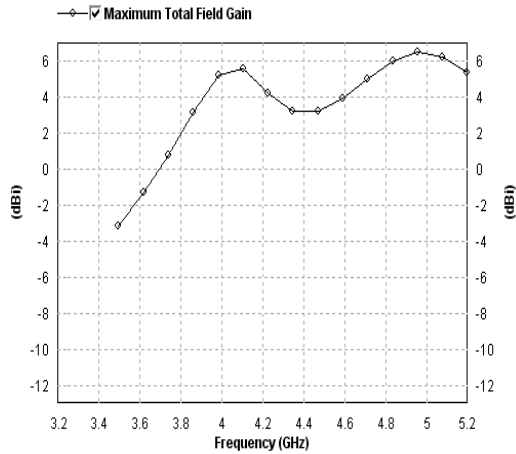
Next figure 5.8 shows the total field directivity of 7.56 dBi at 4.95 GHz. Since the directivity of 7.56 dBi is more than 6 dBi, hence antenna is very fruitful in this regard.

**Fig 16: Directivity Graph (Showing Total Field Directivity of 7.56 dBi at 4.9 GHz Band) for Basic Rectangular Patch**

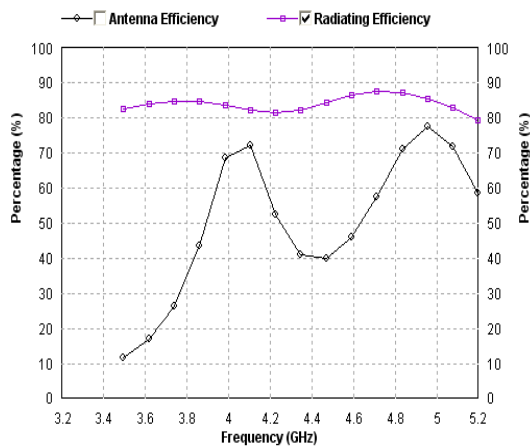


Next is the turn of total field gain, again a good field gain of 6.46 dBi was obtained at 4.96 GHz. Fig. 17 is used to present the total field gain of basic unslotted patch antenna.

**Fig 17: Field Gain Graph (Showing Total Field Gain of 6.45 dBi at 4.9 GHz Band) for Basic Rectangular Patch Antenna**



**Fig 18: Antenna & Radiation Efficiency Graph (Showing Antenna & Radiating Efficiencies of 77.21% & 84.9% at 4.9)**



**3.3.2 Slotted rectangular patch antenna simulation results**

Now next is the turn for slotted rectangular patch antenna. Slotted antenna produce two bands. First band produce results at 3.97 GHz and second at 4.96 GHz. Given below is simulation table of slotted rectangular patch antenna

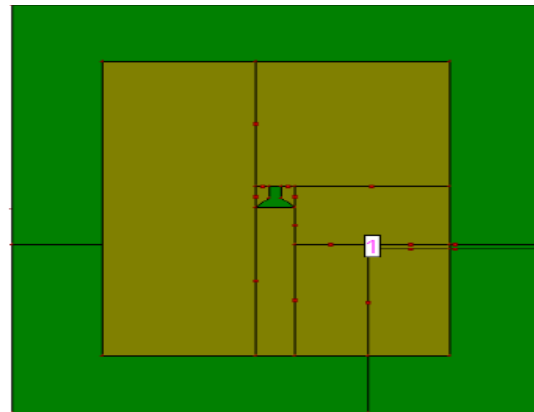
The format of the given simulation table shows the feed point location and return losses at two bands, the first band is showing results at 3.97 GHz and second band is IEEE 802.11y 4.9 GHz band. Many simulations were carried out on IE3D software, but from simulation table the best feed point (5,-3)

having good results is being selected. Hence the rectangular patch antenna showing the respective feed point is given below

**Table 3: Simulation Table for Slotted Rectangular Patch**

S. No.	Feed point location	Return loss(first band)	Return loss(Second band)
1	(1,-7)	-5.52 dB	-1.95 dB
2	(-8,-8)	-9.22 dB	-7.91 dB
3	(-8,-9)	-8.00 dB	-8.29 dB
4	(-8,-10)	-7.9 dB	-8.88 dB
5	(-8,-11)	-8.23 dB	-9.86 dB
6	(-7,-11)	-7.32 dB	-10.67 dB
7	(8,11)	-8.2 dB	-9.86 dB
<b>8</b>	<b>(5,-3)</b>	<b>-12.34 dB</b>	<b>-16.46 dB</b>
9	(8,-10)	-8.26 dB	-8.87 dB
10	(-8,-10)	-8.23 dB	-8.90 dB
11	(4,-3)	-6.91 dB	-15.25 dB
12	(4,-5)	-11.32 dB	-14.13 dB

**Fig 19: Designed Slotted Rectangular Patch Antenna Showing Feed Point (5,-3)**



The two resonant frequencies obtained are 3.97 GHz and 4.96 GHz. The two bands make this antenna useful for two different applications at 3.97 GHz and IEEE 802.11y. The excellent results have been obtained especially for the second IEEE802.11y band; the following table signifies the results The two resonant frequencies obtained are 3.97 GHz and 4.96 GHz. The two bands make this antenna useful for two different applications at 3.97 GHz and IEEE 802.11y. The excellent results have been obtained especially for the second IEEE802.11y band; the following table signifies the results also the return loss of first band is

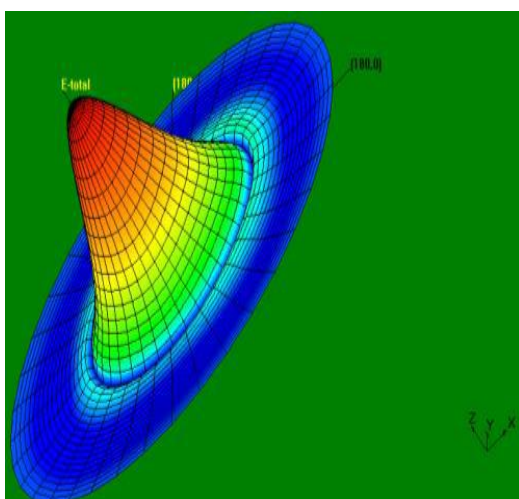


-12.34 dB at 3.97 GHz frequency. Next pages are showing the figures, for various results obtained after simulation of slotted rectangular patch antenna. The figure shown on the very next page is representing the radiation pattern for slotted rectangular patch antenna at 4.96 GHz. Here radiation properties of antenna as a function of space coordinates are represented graphically.

**Table 4: Various Results for the Slotted Patch Antenna**

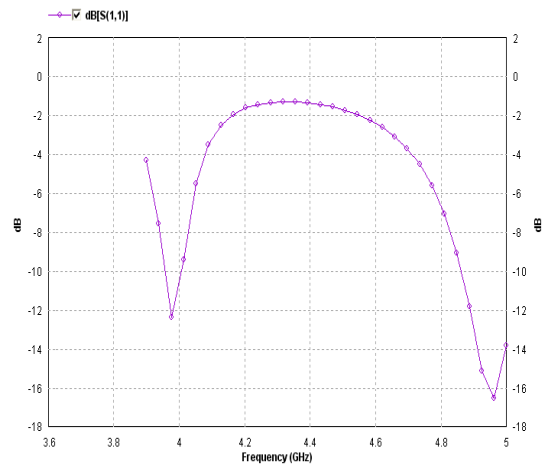
S. No.	Parameter	Results(First band)	Results(Second band)
1	Return loss	12.34 dB	-16.46 dB
2	VSWR	1.68	1.35
3	Antenna efficiency	78%	83.35%
4	Radiation efficiency	83.04%	85.20%
5	Directivity	6.82 dBi	7.58 dBi
6	Field gain	5.74 dBi	6.77 dBi
7	Reflection coefficient	0.23	0.15

**Fig 20: Radiation Pattern of Slotted Microstrip Rectangular Patch Antenna at 4.96 GHz**



The excellent return loss of -12.34 dB at 3.97 GHz and return loss of -16.46 dB for IEEE802.11y is being presented in the figure given below, which was obtained after carrying out many simulations

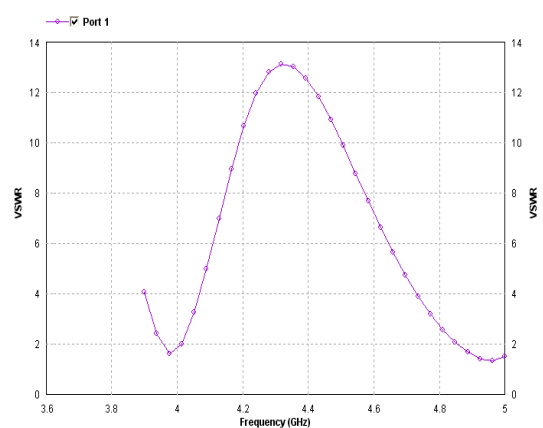
**Fig 21: Return Losses (-12.34dB & -16.46dB at 3.97 GHz & 4.96 GHz Respectively) of Slotted Microstrip Rectangular Patch Antenna at Feed Point (5,-3)**



From Fig. 21, it can be seen that antenna is a dual band antenna which can be used for both 3.97 GHz and IEEE 802.11y applications.

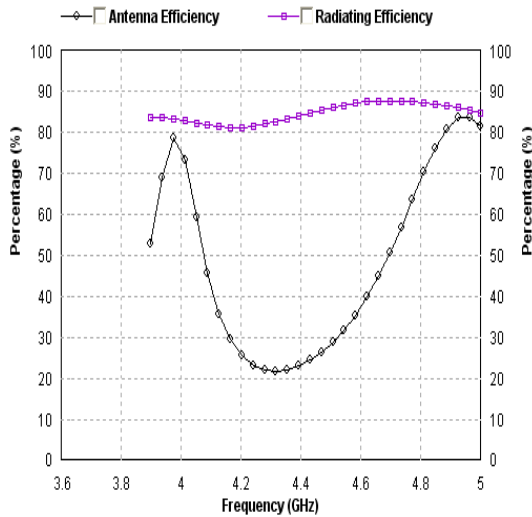
Next to discuss is VSWR, Here VSWR of 1.68 & 1.35 was obtained at 3.97 GHz & 4.96 GHz respectively. Given below is the VSWR graph for the designed slotted microstrip rectangular patch antenna

**Fig 22: VSWR (1.68 & 1.35 at 3.97 GHz & 4.96 GHz Respectively) of Slotted Microstrip Rectangular Patch Antenna**

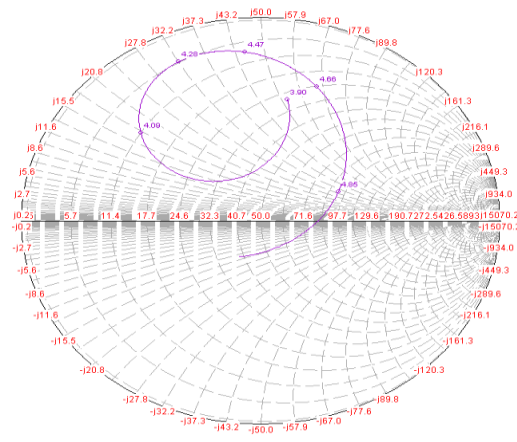


Antenna and radiating efficiencies are also the important properties if both of these are above 80% then antenna is said very efficient. Graph given below shows that obtained antenna and radiating efficiencies for Second band are 83.75% & 85.20% respectively.

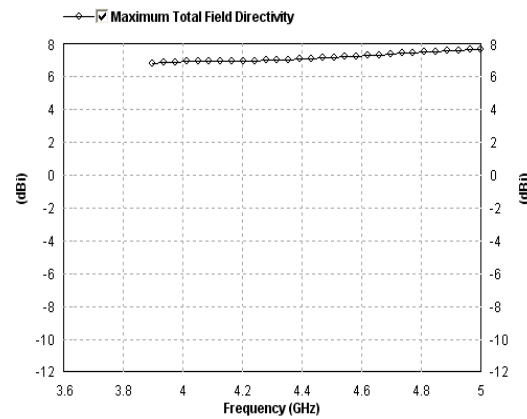
**Fig 23: Antenna and Radiating Efficiencies (Antenna Efficiency 83.35% & Radiating Efficiency 85.20% for the Second Band) of Slotted Microstrip Rectangular Patch Antenna**



**Fig 25: Smith Chart (Showing a Reflection Coefficient of 0.15 at 4.96 GHz) for Slotted Rectangular Patch Antenna**

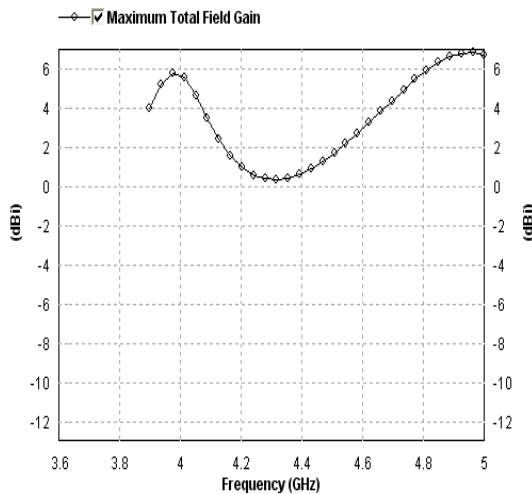


**Fig 26: Directivity Graph (Showing a Directivity of 7.58 at 4.96 GHz) for Slotted Rectangular Patch Antenna**



Next to discuss is field gain which is also a very important property. It should be above 6 dBi. For slotted rectangular patch antenna the obtained field gain is 6.77 dBi at 4.96 GHz. Graph for field gain is shown in Fig. 24

**Fig 24: Field Gain (6.77dBi for the Second Band) of Slotted Microstrip Rectangular Patch Antenna**



Also the smith chart for slotted rectangular patch antenna is shown in the Fig. 15 given below. Finally they obtained total field directivity for slotted patch antenna is presented in Fig 26

**4.0 Conclusion**

The designed microstrip rectangular patch antenna is dual band antenna which can be used for IMT band and Public safety spectrum (4.940 GHz-4.990 GHz) applications. A return loss and VSWR at 4.96 GHz found to be -16.46 dB and 1.35 respectively for slotted microstrip rectangular patch antenna; also Antenna efficiency for the same found to be 83.35% at 4.96 GHz which shows the excellent performance of antenna for IEEE 802.11y applications. In addition a return loss of -12.34 dB at 3.97 GHz proves that this slotted antenna is dual band. Also it has been seen previously that, without slotting the rectangular patch antenna have return loss of -10.33 dB at 4.96 GHz. Finally after comparing the

various results of two antennas, it can be seen that slotted antenna has better return loss, VSWR, reflection coefficient, directivity, total field gain, antenna efficiency and radiating efficiency.

In future the multiband antenna array could be designed where various properties of patch antenna can be improved up to the top level.

### Reference

- [1] V. K. Singh, R. Kumbhare, Comparison of Microstrip Antenna and Microstrip Antenna With Slots For Microwave Life Detection System, *International Journal of Scientific Research Engineering & Technology*, 1(4), 2012, 088-091
- [2] U. Chakraborty, S. Chatterjee, S. K. Chowdhury, P. P. Sarkar, A Compact Microstrip Patch Antenna For Wireless Communication, *Progress In Electromagnetics Research C*, 18, 2011, 211-220
- [3] S. Das, P. P. Sarkar, S. K. Chowdhury, A Compact Novel Multi Frequency Slotted Microstrip Patch Antenna for WiMAX and C Band Application, *Journal of Engineering Research and Studies*, 3(2), 2012, 57-59
- [4] S. K. Behera, Novel Tuned Rectangular Patch Antenna As a Load for Phase Power Combining, Ph. D Thesis, Jadavpur University, Kolkata.
- [5] B. Mazumdar, A compact L slit Microstrip antenna for GSM, Bluetooth, WiMAX & WLAN Applications, *International Journal of Engineering Research and Applications*, 2, 2012, 687-691
- [6] Islam, Hussein, Hani, 3 port MIMO antenna for 4G application, *International Journal of Advanced in research and Technology*, 1(4), 2012,
- [7] C. A. Balanis, *Antenna Theory, Analysis, Design*, John Wiley & Sons, New York, 1997
- [8] V. K. Singh, Z. Ali, A. K. Singh, Dual wideband stacked patch antenna for WiMAX and WLAN applications, *International Conference on Computational Intelligence and Communication Systems*, IEEE, 978-0-7695-4587-S/11, 2011
- [9] S. Subahir, N. Binti Abd Wahab, Wan Norsyafizan W. Muhammad, A dual frequency microstrip patch antenna for GPS and WiMAX application, *IEEE International RF and Microwave Conference (RFM 2011)*, 978-1-4577-1631-7, 2011
- [10] Dheeraj, Deepak, Komal, Design of dual band broadband modified rectangular microstrip antenna with air gap for wireless applications, *International journal of enhanced research in science technology & Engineering*, 3(2), 2014